

7 UHQFK 026 %DUULHU 6FKRWWN\ 5H

TO-220AB
TSR 6 & 7



ITO-220AB
TSR 6 & 7)



Features

- ‡ \$GYDQWUHQFK WHFKQRORJ\
- ‡ /RZRZURGRWDJH GURS
- ‡ /RZRZURVVHV
- ‡ +LJKILFLHQF\ RSHUDWLRO
- ‡ /HDGH)HLQLVK &R#6OLDQW

Applications

- ‡ '&' & RQYHUWHUV
- ‡ \$&' & \$GDSWRUV
- ‡ 6ZLWFKRZHXSSOLHV
- ‡)UHHZKHHLRGLQJ

Maximum ratings and electrical characteristics (T_J = 25°C unless otherwise noted)

3DUDPHWHU	6\PERO	/LPLW	8QLW
0D[LPXPHSHVSHUNYHYURQHW DJH	9550		9
0D[LPXPHYHURJHZDUG UFKUWHIHWG SHGLRGH	,) \$9		\$
3HDN IRVZDUEBUUHQW VLKDDHQH ZDYH VXSHULPSRVHGRFSGUDRVGHG	,)60		\$
2SHUDMXQDQGRQWRUDJH WHPSHUDW XUHURDJH WR			f &
7\SLFVCHUPDO USHVULVQHDQFH	72 \$% ,72 \$%		f & : f & :
,QVWDQWDQHRROWRUJZDUG SHGLRGH	9)	7 < 3	0\$;
		43	48
		38	
		0.73	0.79
		0.68	
,QVWDQWDQHRXUUSHOMRQVH UDWHYHYURQHW DJH	,5		X\$
			P\$

1RWHV
3XOVH WHVVSXOVH ZLGWK GXW\F\FOH
3XOVH WHVW 3XOPVH ZLGWK 0

.I \$YHUDJH)RUZDUG &XUJHQW

RATINGS AND CHARACTERISTICS CURVES 7\$ f & XQOHVQRWKBUZLVH

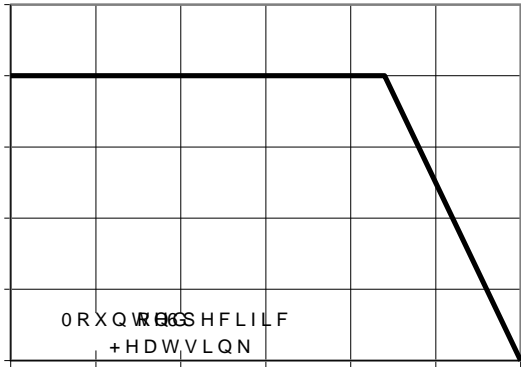

7F&DV7HP\$&

Current Derating, Case

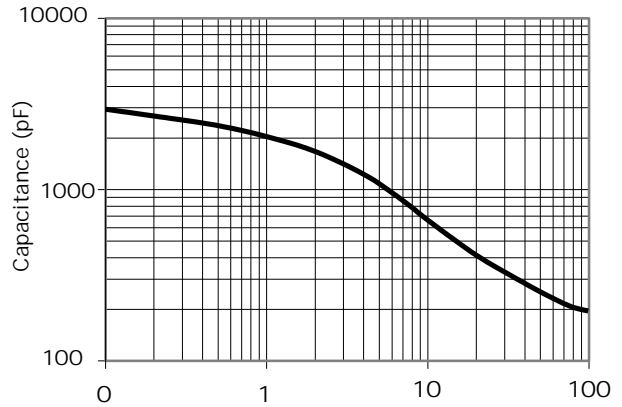

5HYHQRW9JH

Typical Junction Capacitance

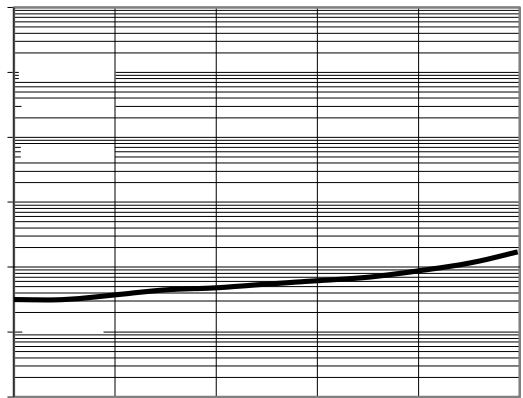

PACKAGE OUTLINE DIMENSIONS

1 R W H X Q L W , Q P P

TO-220AB

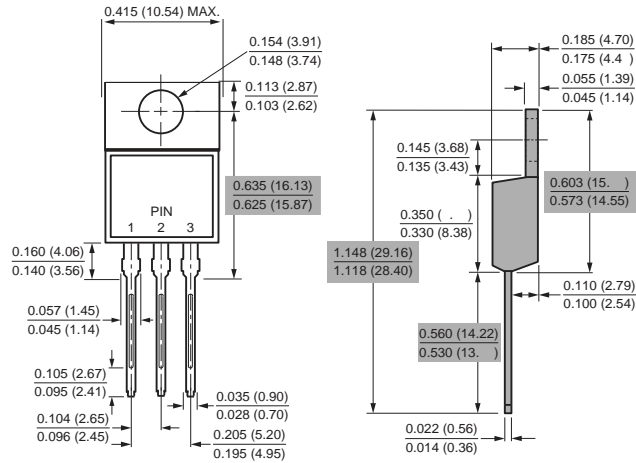

ITO-220AB

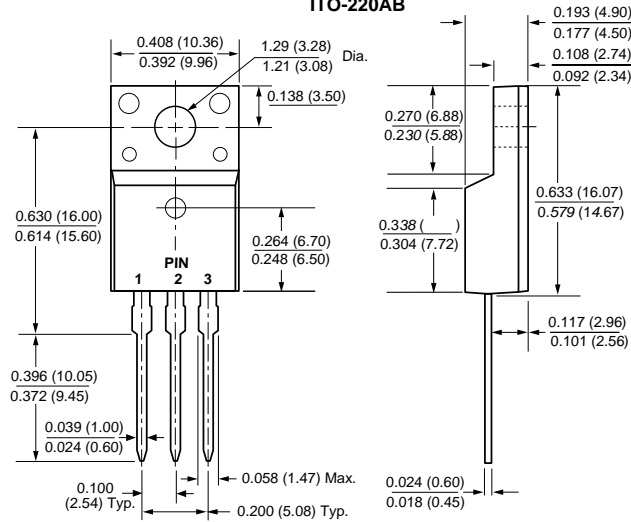

Marking Information

: &RPSDQ\ V WUDGHPDUN
83URGXFW P65GH O &7 RU 765 6 &7)
93'& LQIRU EDWLRQ

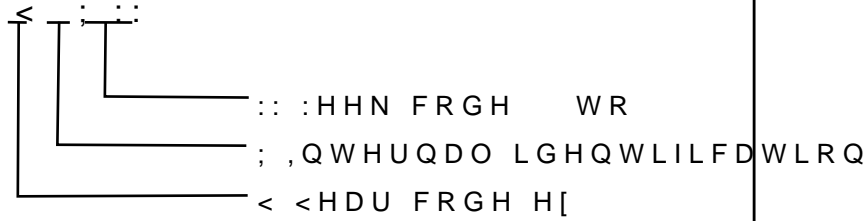

Packaging Information

7XEH 'LPHQVLRQV

,QVLGH %R[

2XWVLGH %R[

Packaging Information