

2SHUDMXLQBDQCRQWRUDJH WDE\$HUDW X0H767*		WR		f &		
7\SLFDO WKHUPDO UHVLVWDQFH SHU		GL5861 0RXQWHG RQ)5		3&f% :		
,QVWDQWDQHRROWRDUZDUC SHGLRGH		9)	7<3	0\$;	9	
	,) \$		7- f&			
	,) \$		7- f&			
	,) \$		7- f&			
	,) \$		7- f&			
1RWHV		3XOVH WHVW3XOVH ZLGWK GXW\ F\FOH		3XOVH WHVW 3XOVH ZLGWK 0		

RATINGS AND CHARACTERISTICS CURVES (TA = 25 °C unless otherwise noted)

PACKAGE OUTLINE DIMENSIONS

7 2

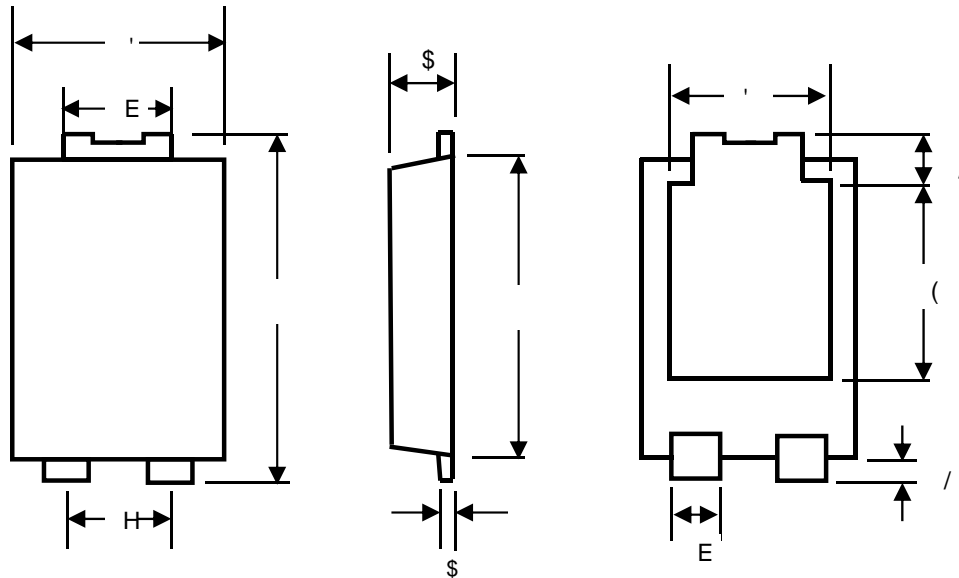

TO-277 mechanical data

81,7		\$	\$	E	E	'	'	(((/	/
PP	PD[
	PLQ											
PLO	PD[
	PLQ											

7 2 Suggested Pad Layout

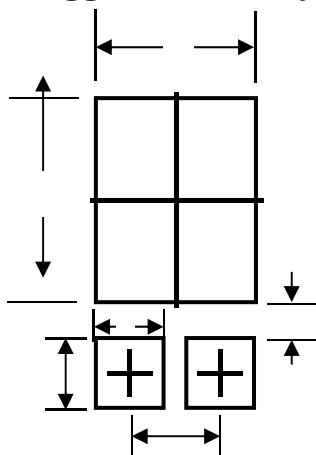

81,7		&	*	;	;		
PP	PLQ						
PLO	PLQ						

Marking Information

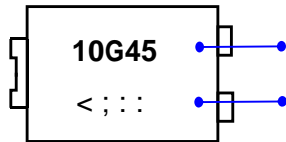

3URGXFW PRGHO 76310U45SPG
WR DU4510

3' & LQIRUPDWLRQ

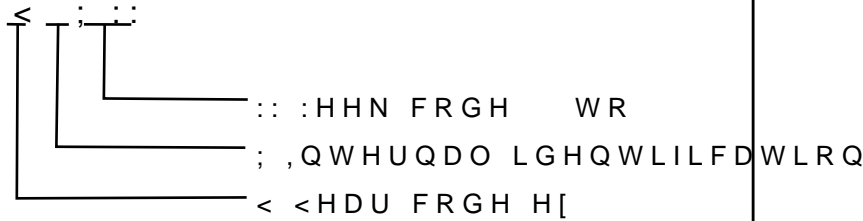

Packaging Information

5HHO 'LPHQVLRQV

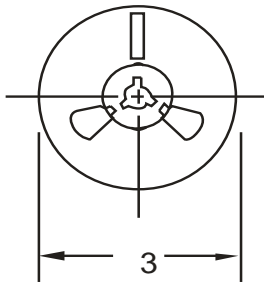

,QVLGH %R[

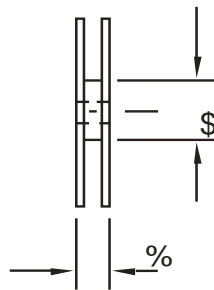

2XWVLGH %R[

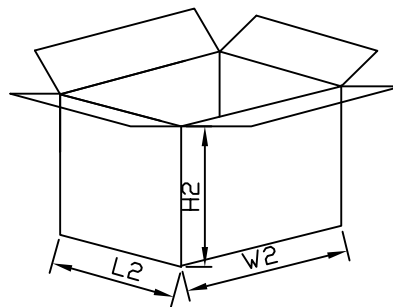
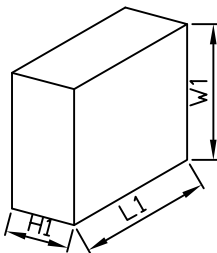

Packaging Information

12	81,7	5HHO'PHQVLRQV	,QVLGH[2XWVLGH %R[
		\$	%	/ : +
6L]H	PP			
47<	3&6	6PDOOHVW SDFNDJH	3&6 UHHO	3&6 UHHO
1RWH		7ROHUDQFH PP	PP PP	PP PP