

7UHQFK 026 %DUULHU 6FKRWWN\ 5H

TO-220AB
TSR30L200CT

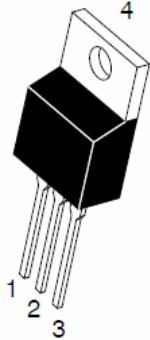

ITO-220AB
TSR30L200CTF

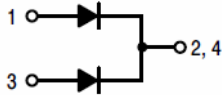

Features

- ‡ \$GYDQWUHQFK WHFKQRORJ\
- ‡ /RZRZDWRGWDJH GURS
- ‡ /RZRZDWRVVHV
- ‡ +LJKILFLHQF\ RSHUDWLRO
- ‡ /HDGH)HLQLVK &R#6OLDQW

Applications

- ‡ '&' & RQYHUWHUV
- ‡ \$&' & GDSWRUV
- ‡ 6ZLWFKRZDUXSSOLHV
- ‡)UHHZKH'HLRGLQJ

Maximum ratings and electrical characteristics (T_J = 25°C unless otherwise noted)

3DUDPHWHU		6\PERO	/LPLW	8QLW
0D[LPXPHSHVSHUNYHYURQHW DJH		9550		9
0D[LPXPHYHURJHJZDUG UFXEWHHJZDUG SHGLRGH		,) \$9		\$
3HDN IRVZDUEBUUHQW VLKDDHQH ZDYH VXSHULPSRVHGRFSGUJDRVHG		,)60		\$
2SHUDMXQDQGRQWRUDJH WHPSHUDW XUH 0DQJH WR				
7\SLFVQCHUPDO USHVULVQHDQFH		72 \$%		f & :
		,72 \$%	5\$-&	f & :
			7<3	0\$;
,QVWDQWDQHRRQWRUJZDUG SHGLRGH		,) \$ 7- f&	9)	9
		,) \$		
		,) \$		
		,) \$ 7- f&		
,QVWDQWDQHRXUUSHQWRUJZDUG UDWHYHUVH				
1RWHV				
3XOVH WHVVSXOVH ZLGWK GXW\F\FOH				
3XOVH WHVW 3XOPVH ZLGWK 0				

RATINGS AND CHARACTERISTICS CURVES (TA = 25 °C unless otherwise noted)

If, Average Forward Current (A)

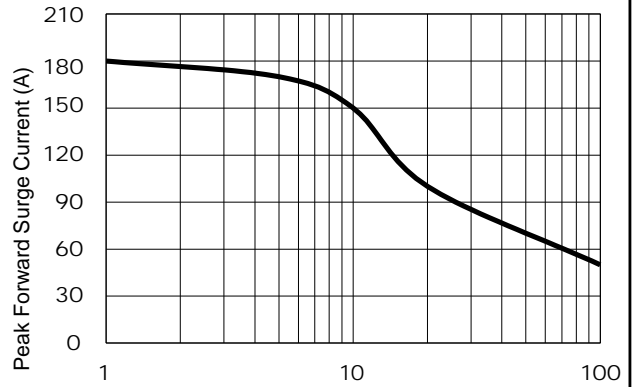

Tc, Case Temp (°C)

Figure 1: Current Derating, Case

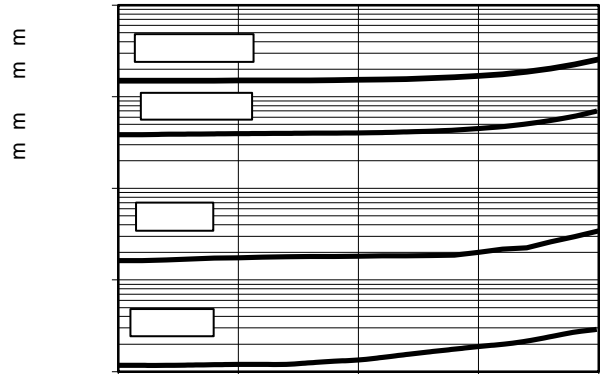
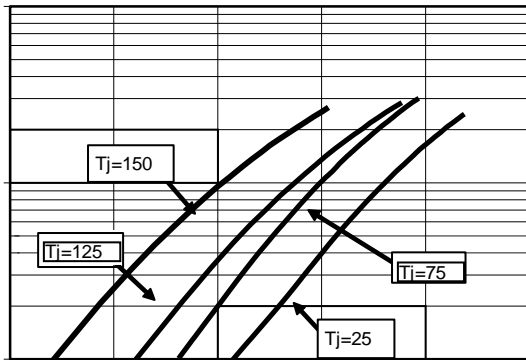

PACKAGE OUTLINE DIMENSIONS

Note:unit In(mm)

TO-220AB

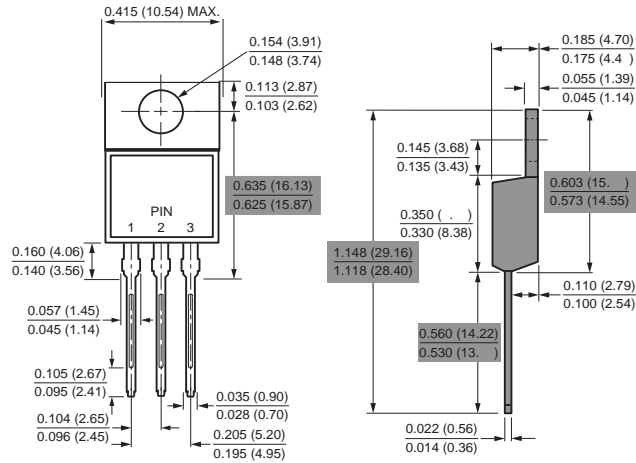

ITO-220AB

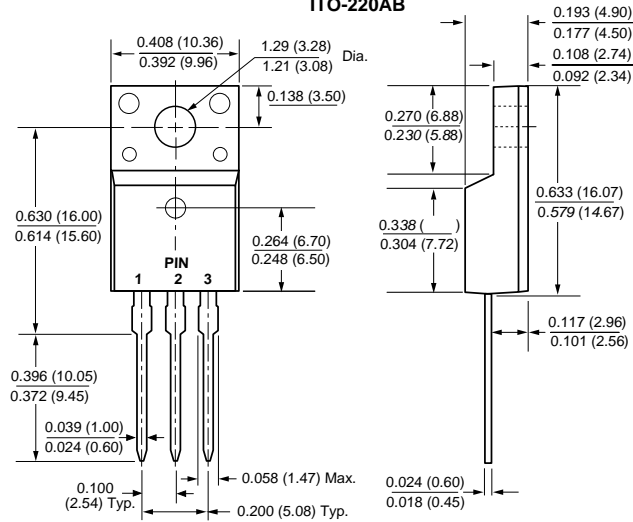

Marking Information

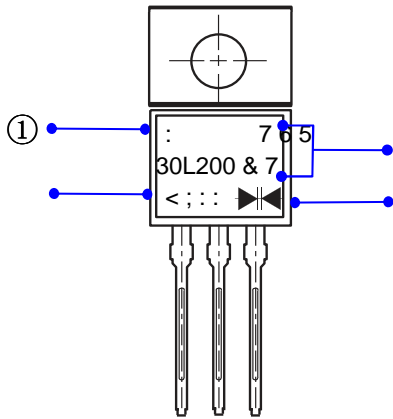

- ①
- ② 3 U R G X F W
- ③ 3 ' & L Q I R U P D W L R Q

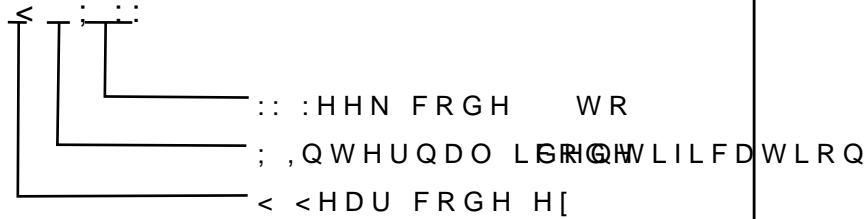

Packaging Information

7 X E H ' L P H Q V L R Q V

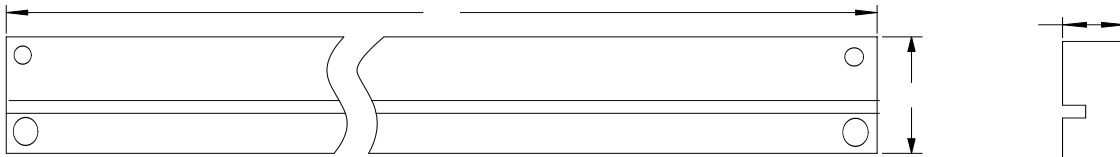

, Q V L G H % R [

2 X W V L G H % R [

Packaging Information

1 2	8 1 ,	7 X E H ' L P H Q V L R			, Q V L G H % R [2 X W V L G H % R [
6 L] H	PP	\$	%	&	/	:	+	/	:	+
4 7 <	3 & 6	3 & 6 7 X E H			6 P D O C S D F W D J H 3 & 6 W X E G V R W D O			3 & 6 F D U E R G L W R W D O		
1 R W H		7 R O H U D Q F P P " P P			P P " P P			P P " P P		