

7UHQFK 026 %DUULHU 6FKRWWN\ 5H

)HDWXUHV

‡ \$GYDQWUHQFK WHFKQRORJ\
 ‡ /RZRUZDURGDWDJH GURS
 ‡ /RZRZURVVHV
 ‡ +LJHILFLHQF\ RSHUDWLRQ
 ‡ /HDGH)HLQLVK &RPSOLDQW

\$SSOLFDFWLRQV

‡ '&' &RQYHUWHUV
 ‡ \$&' &GDSWRUV
 ‡ 6ZLWFKRZHS\$SSOLHV
 ‡)UHHZKHHLRGLJ

0D[LPXP UDWLQJV DQG HOHFWULFDJ&FXODDPRVHUQRWHIGFV

3DUDPHWHU		6\PERO	/LPLW	8QLW
0D[LPXPHSHVSHUNYHYURQWDJH		9550		9
0D[LPXPYHURJHZDUG UFXEWHIQWG		,) \$9		\$
3HDN IRUZDURSUHQW VLQRDQZDYH VXSHULPSRQDURSRGLRGH		,)60		\$
2SHUDMXQRDURQRWRUDJH WDRSHUDW		XUH 767	WR	
7\SLFDO WKHUPDO UHVLVWDQFH SHU		GLSRGH	ORXQWHG RQ)5	3&f% :
,QVWDQWDQHRRQWRDURJZDUG SHGLRGH	,) \$	7- f&	7<3	0\$;
	,) \$	7- f&		9
	,) \$	7- f&		
,QVWDQWDQHRXUUSHQWRDURJZDUG UDWHYHYURQWDJH	,) \$	7- f&		X\$
	,) \$	7- f&		P\$

1RWHV

3XOVH WHVVSXOVH ZLGWK GXW\FFOH
 3XOVH WHVW 3XOVH ZLGWK 0

5\$7,1*6 \$1' &+\$5\$&7(5, 6 &7859(6f& XQOHVQRWKBUZLVH

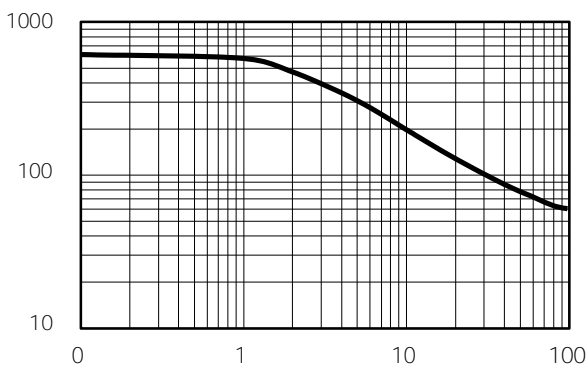
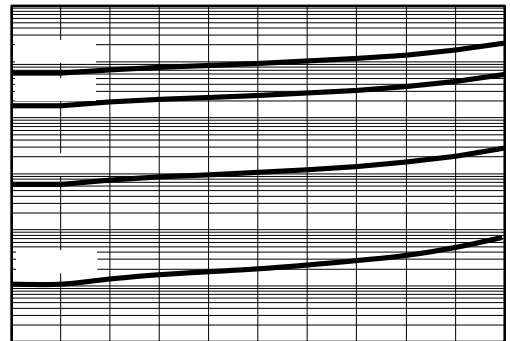
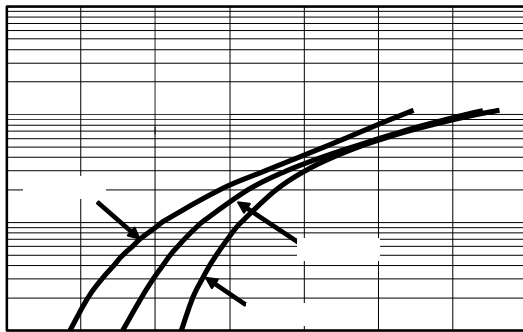
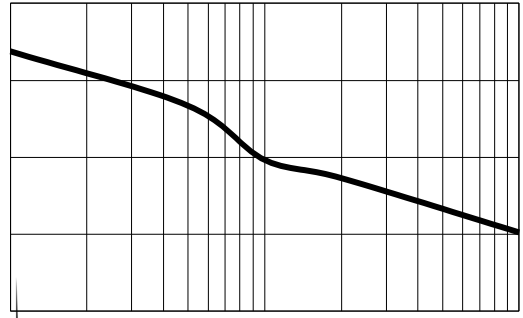
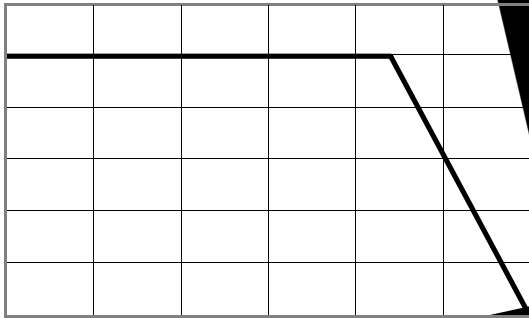

5HMH R0WJH9

3\$&.\$*(287/,1(',0(16,216

72

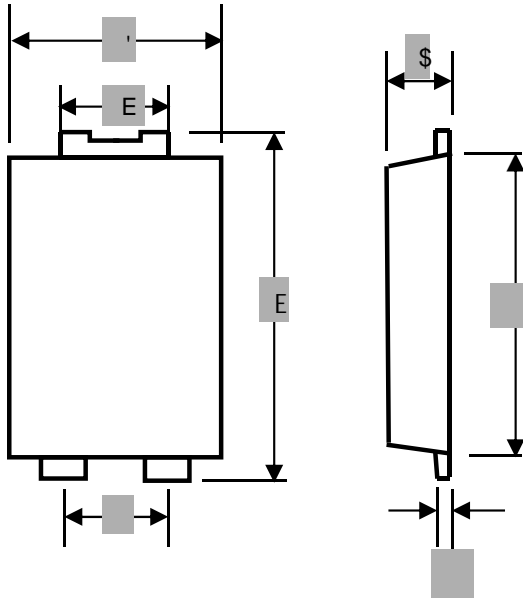

0DUNLQJ ,QIRUPDWLRQ

3URGXFW PRGHO 763 / 63 5HIHUL
WR DV \$
3' & LQIRUPDWLRQ

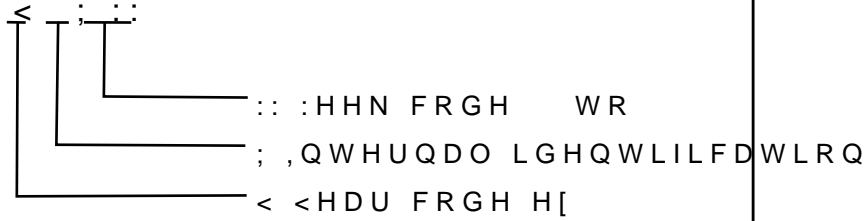
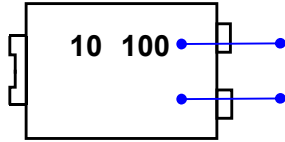

3DFNDJLQJ ,QIRUPDWLRQ

5HHO 'LPHQVLRQV

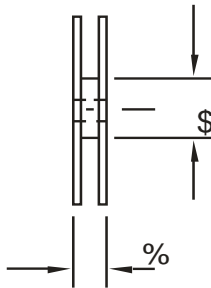
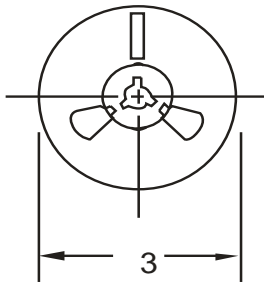

,QVLGH %R[

2XWVLGH %R[

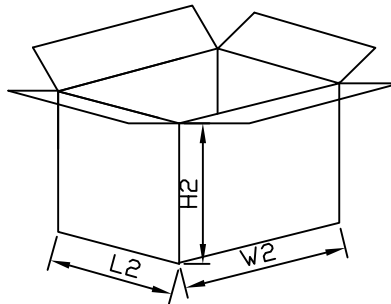
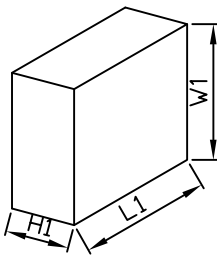

3DFNDJLQJ ,QIRUPDWLRQ

12	81,	5HHO 'LPHQVLR	,QVLGH %R[2XWVLGH %R[
6L]H	PP			